

# DISCOVERY 2.4GHz RTR R/C RACING SAILBOAT

Model No:8810



## SPECIFICATION:

- Length:655mm
- Beam:150mm
- Mast height:915mm
- Overall height:1338mm
- RTR total weight:1325g
- Sail area (Main):14.6 dm<sup>2</sup>
- Sail area (Jib):7.66 dm<sup>2</sup>
- Sail area (Overall):22.26 dm<sup>2</sup>
- Hull material:Plastic molded with colorful printing decal stickers and painting
- Required: 4“AA”batteries for transmitter  
4“AA”batteries for receiver

# INSTRUCTION MANUAL **THIS MODEL IS NOT A TOY!**

THESE INSTRUCTIONS SHOULD BE READ BY A SUPERVISING ADULT

## DISCOVERY 2.4GHZ RTR SAILBOAT

Model No.: 8810

### IMPORTANT :

1. This is not a toy. Assembly and operating of this boat requires adult supervision.
2. Please take time to read the instructions carefully and completely before attempting to operate your model.  
This manual contains the instructions you need to safely build, operate and maintain your R/C sailboat.

### CONTENTS OF KITS



Hull with winch servo, rudder servo, battery box & receiver pre-installed



2.4GHz 2CH Transmitter



Jib Sail & Main Sail



Rudder



Keel



Balance weight



boat stand



EVA



Long mast & Short mast



Jib boom & Main boom



Mast fitting tube



Rudder arm



M5X12 Inner hexagon screw  
M5x20 Inner hexagon screw



Masthead swivel

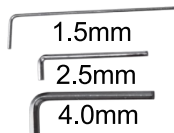

Allen key

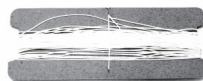

Dyneema cord



Spare rubber band



Metal backstay crane



10 pcs Bowsie



Forestay fitting



2pcs Cord  
attachment clip



Screws &  
Nuts for boat stand



3pcs main sail  
luff ring

**NOTE:** Some components and parts are located on the back side of the polyfoam tray.

### ITEMS REQUIRED FOR COMPLETION

Eight "AA" Alkaline batteries. (four for the transmitter, four for the receiver battery box.)

# BASIC BOAT TERMINOLOGY

**BOW:** The front of the boat.

**STERN:** The back of the boat.

**PORT:** This is the left side of the boat when view the boat from the stern. An easy way to remember this is that port and left both contain four letters.

**STARBOARD:** This is the right side of the boat when view the boat from the stern.

**HULL:** The body of the boat.

**DECK:** The top of the boat.

**KEEL:** A weighted blade that protrudes from the bottom of the hull as a means of providing lateral stability.

**RUDDER:** The hinged vertical plate mounted at the stern that controls steering.

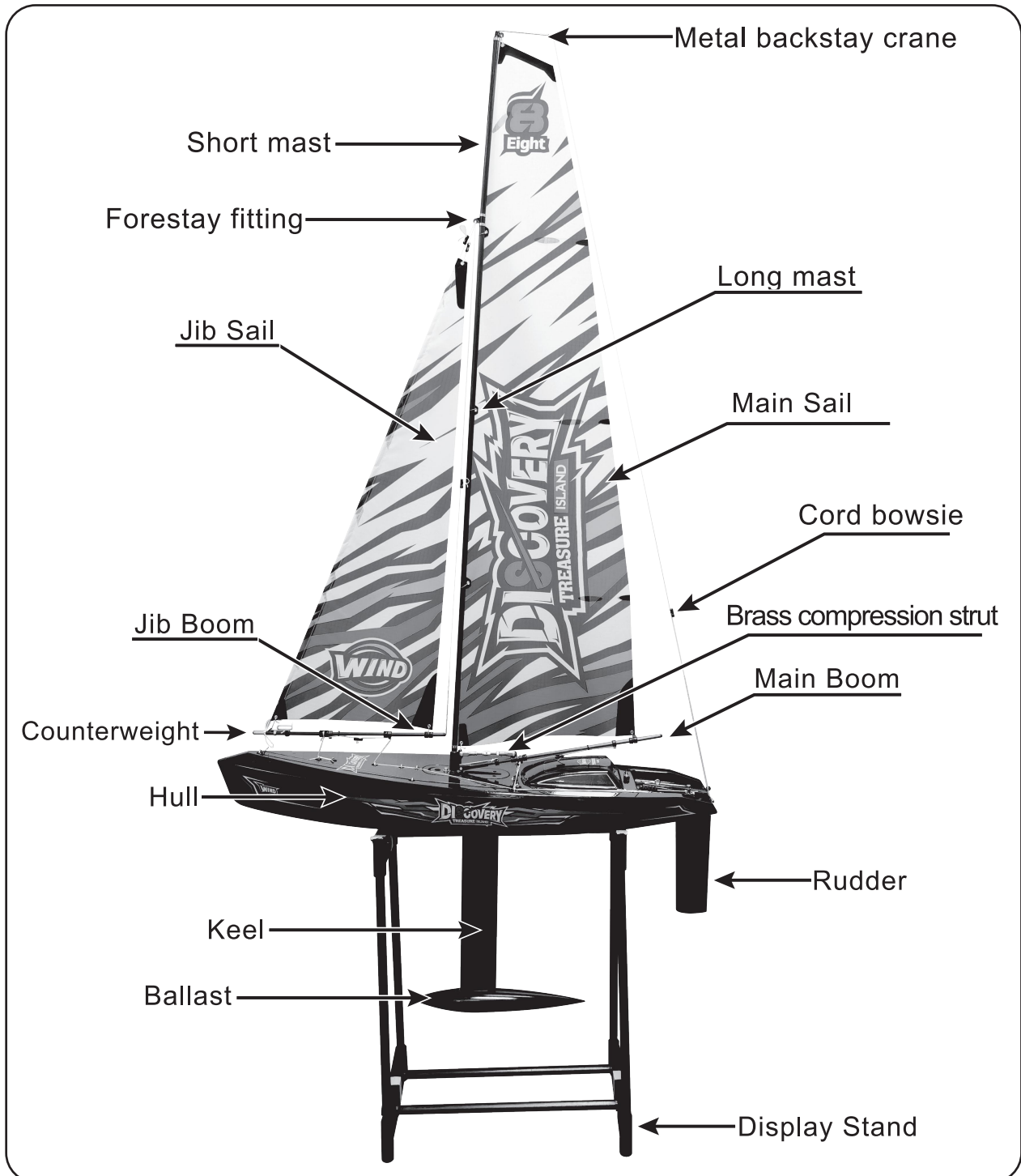

## DISPLAY STAND ASSEMBLY

1. Take polyfoam out from inner box, take boat stand out which are placed on the bottom of polyfoam.
2. Assemble boat stand as photos shown. Notice four longer tubes are side ones, while three shorter tubes are top and bottom ones.
3. Locate the EVA on the hull support as shown. This will protect the hull bottom from scratches during construction and storage.

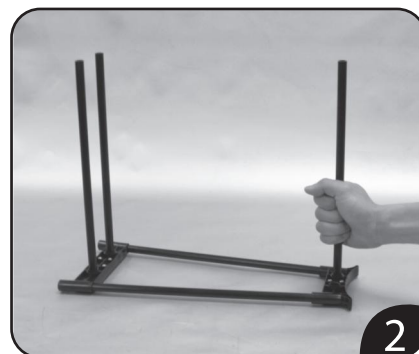
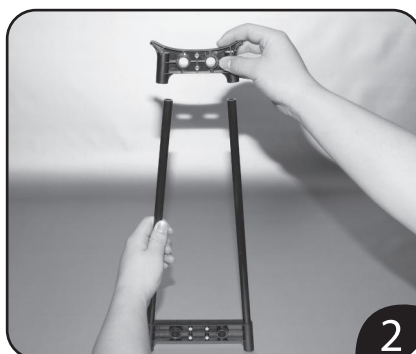

## KEEL & BALLAST & RUDDER ASSEMBLY

1. Secure keel and ballast with M5x12 screw and 4.0mm allen key.
2. Secure keel and hull with M5x20 screw and 4.0mm allen key.

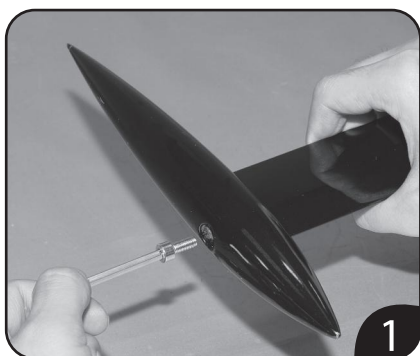

3. Insert the rudder shaft up through the bottom of the stern of hull. Notice the rudder's direction. Use 2.5mm allen key to secure the rudder shaft on the rudder arm. Make sure rudder can freely rotate and the gap for up and down is no more than 0.5mm
4. Pushrod go through clevis on rudder arm, make sure rudder is on the center line of hull, then use 2.5mm allen key to tighten clevis screw.

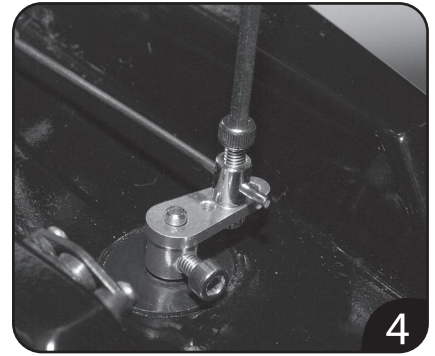
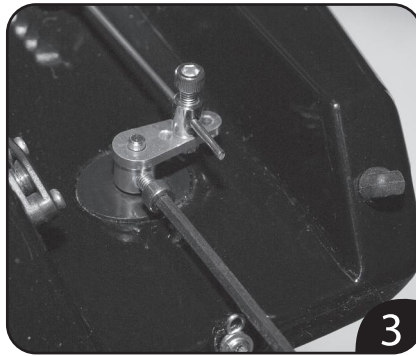
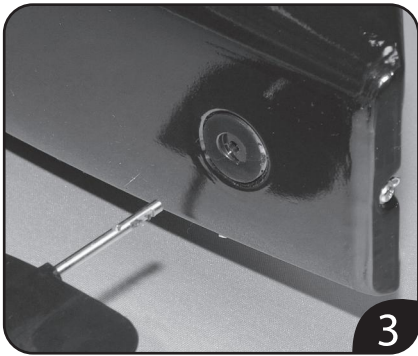

## MAIN SAIL RIGGING

1. Use mast fitting tube (longer side) to thread through bearing on main boom, insert mast fitting tube in main mast mount as shown. See page 6.
2. Insert long mast in mast fitting tube (shorter side). See page 6.
3. Thread three mainsail luff rings through long mast. See page 6.
4. Thread metal backstay crane through mast head swivel and insert in short mast. See page 6.
5. Insert short mast into forestay fitting, then insert into long mast. Cut a length of Dyneema cord at around 1300mm, attach it to metal backstay crane eyelet, the other end of cord thread through a bowsie's two holes in proper order, through stern eyelet then attach cord to the end eyelet of bowsie. adjust cord bowsie to pull cord tight and straight. See page 6.
6. Cut a length of Dyneema cord at around 100mm, use it to attach eyelet on mainsail tip to mast head swivel eyelet. Notice that gap between mainsail tip and swivel is within 6mm-10mm. See page 6.
7. Adjust silicone rings ("SR" for short) positions on main boom as shown.
8. Cut a length of dyneema cord at around 150mm, attach it to eyelet in bottom left corner of main sail. The other end of cord thread through eyelet on top of main boom bearing from front side to back side, then thread through eyelet on bottom of main boom bearing from back side to front side, at last attach cord to silicone ring "SR1". Move SR1 to pull main sail tight.
9. Use main boom metal sail clew hook to attach with eyelet on bottom right corner of main sail. You can adjust the main sail shape by moving the SR3 and SR4 silicone rings position on main boom. Use hand to rotate the brass compression strut to adjust the angle between main boom and mast. After getting the angle you want, screw the nut tighten to secure firmly the brass compression strut. So that the main boom could pull the bottom right corner of mainsail tight. But remember not to pull mainsail too tight. See page 6.

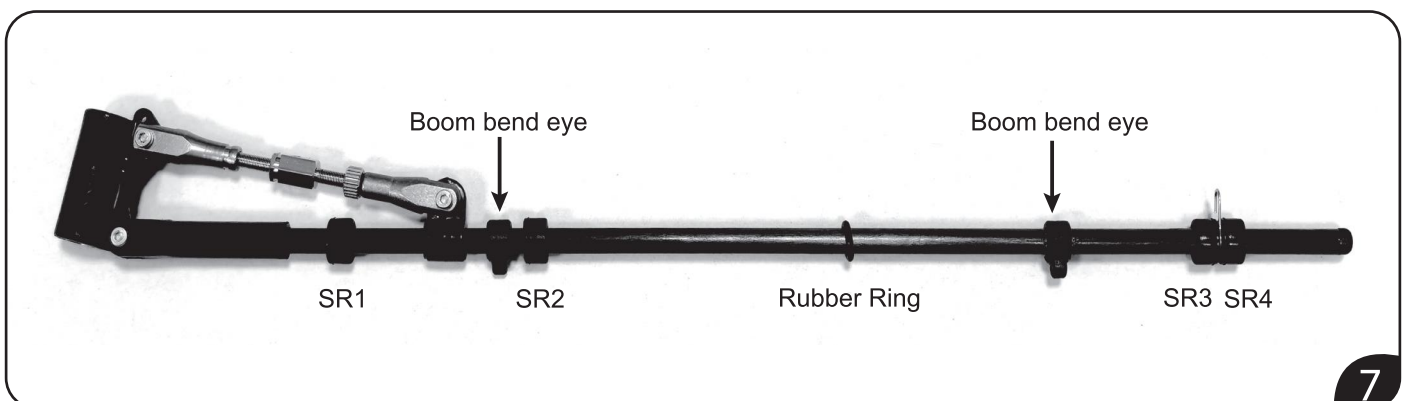

# MAIN SAIL RIGGING

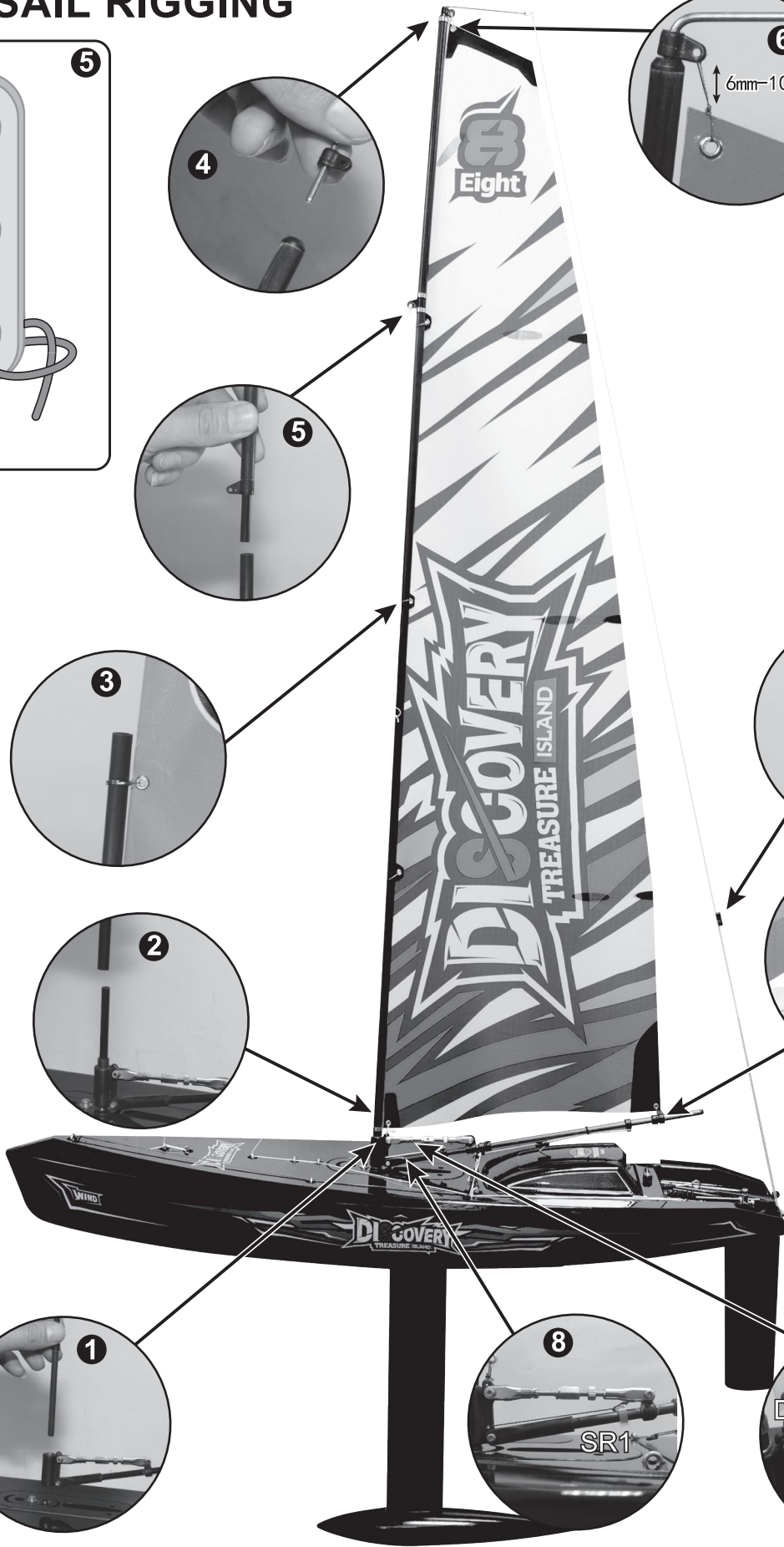
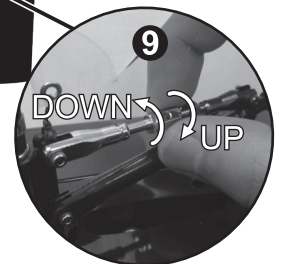
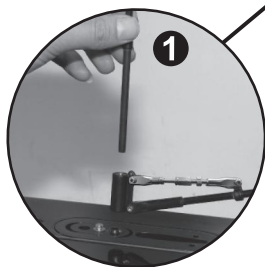
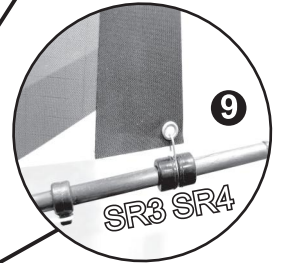
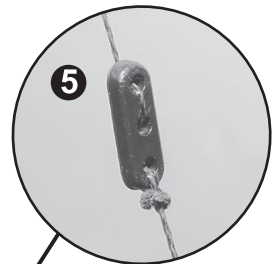
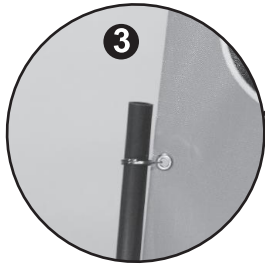
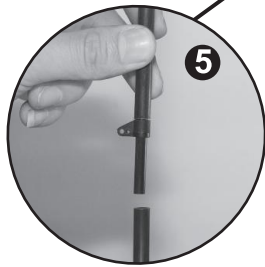
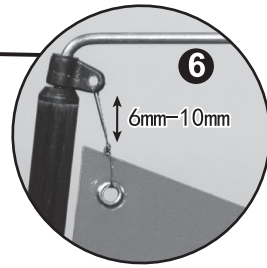
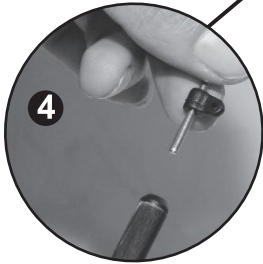
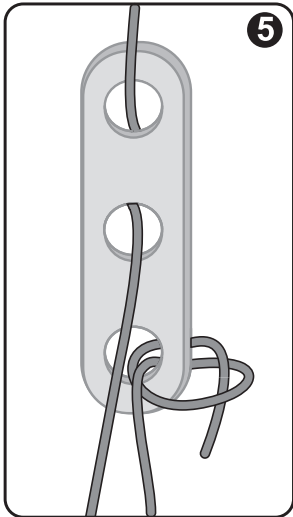

# JIB SAIL RIGGING



1

1. Adjust silicone rings ("SR" for short) positions on jib boom as shown.
2. Use forestay cord on the bottom left corner of jib sail to tie a loop, then loop around jib weight shaft. Cut a length of Dyneema cord at around 100mm, attach it to eyelet in bottom left corner of jib sail, the other end of cord thread through eyelet in jib boom front end fitting, then attach cord to silicone ring "SR1" on jib boom. Adjust SR1 position to adjust jib sail distance from jib boom around 3mm-5mm.
3. Use jib boom metal sail clew hook to attach with eyelet on bottom right corner of jib sail. You can adjust the jib sail shape by moving the SR5 and SR6 silicone rings position on jib boom.
4. Use forestay cord on jib sail tip to thread through a bowsie's two holes in proper order, then through eyelet in forestay fitting, attach cord to end eyelet of bowsie (Tips: ensure bowsie is closer to forestay fitting for easy adjustment).
5. Cut a length of Dyneema cord at around 150mm, attach it to eyelet in jib sail tip, the other end of cord thread through a bowsie's two holes in proper order, then through eyelet in forestay fitting, attach cord to end eyelet of bowsie (Tips: ensure bowsie is closer to forestay fitting for easy adjustment). This cord is Jib Sail Lifting.
6. Use jib boom lifting cord to thread through a bowsie's two holes in proper order, then through eyelet in forestay fitting, attach cord to end eyelet of bowsie.
7. Cut a length of Dyneema cord at around 200mm, attach it to jib boom tube between "SR2" and "SR3", the other end of cord is threaded through Deck Eye 2, Then tie a loop, the loop attach to deck eye 3 hook. Now adjust three cord bowsie (Forestay cord, Jib Sail Lifting cord and Jib Boom Lifting cord) tight, so to make sure Jib Boom is 25mm-30mm top above deck level. Then adjust SR2, SR3's position on jib boom to pull jib boom, ensure jib boom end is around 5mm distance to mast.

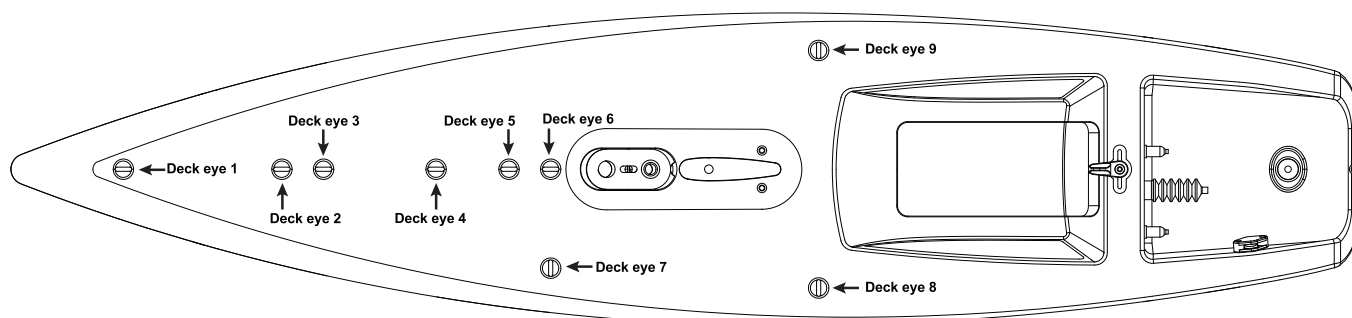

# JIB SAIL RIGGING

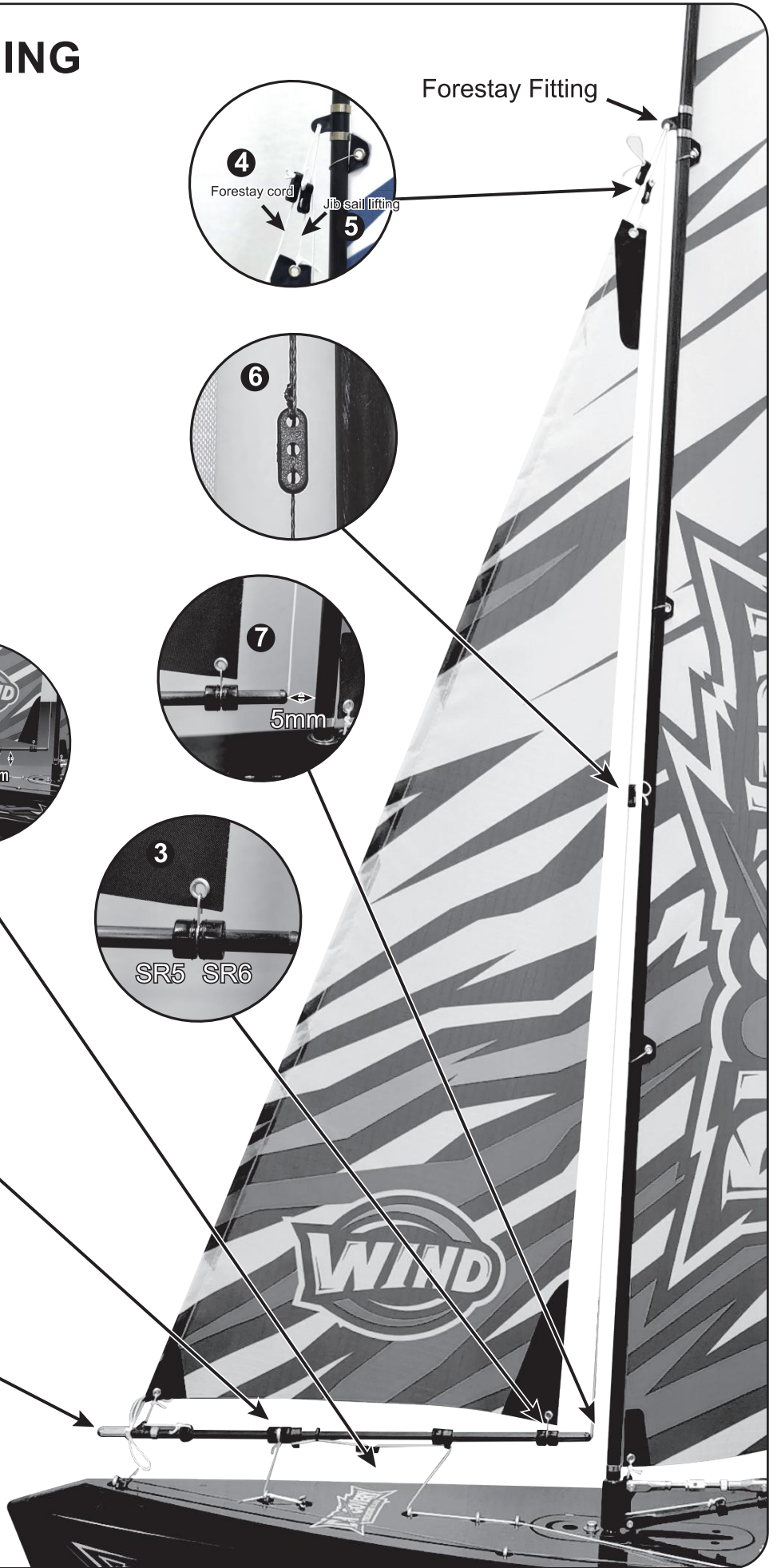
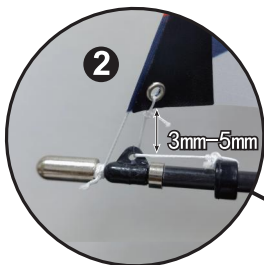
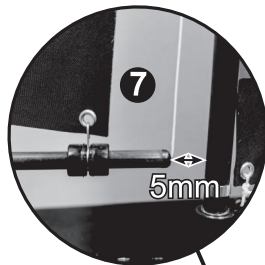
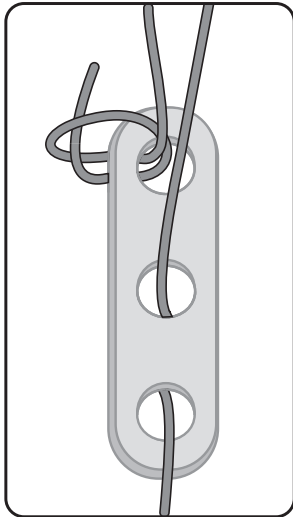



## MAST, JIB SAIL, MAIN SAIL ADJUSTMENT

1. Mast sliding mount is pre-set in factory as photo shown. This setting will ensure top of mast raked back around 40mm from vertical line for a standard rig setup when backstay and forestay cord are pulled tighten. If mast sliding mount is not pre-set like this, you could use 2.5mm allen key to loose mast sliding mount screw and move mast sliding mount forward or backward. Depend on different wind power, you need to learn yourself to adjust the mast sliding mount position, so that change the mast raked front or back.
2. Adjust backstay cord bowsie and forestay cord bowsie to pull these two cord tension.
3. Adjust SR1 position on Main Boom, brass compression strut to pull mainsail tight after the above rig has been setup. Adjust SR1 position on Jib Boom, Jib Sail Lifting cord bowsie to pull Jib Sail tight. Remember not to pull mainsail and Jib Sail too tight.
4. Normally, in strong wind, move SR3 and SR4 position to right side on Main Boom , move SR5 and SR6 position to right side on Jib Boom, so these setting can adjust the mainsail and jib sail's radian smaller. In light wind, move these rings' position to left side on Main boom and Jib boom, so these setting can adjust the sails' radian bigger. You need to learn youself in sailing to master the settings base on different wind power.

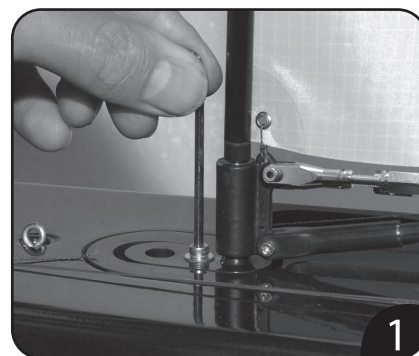
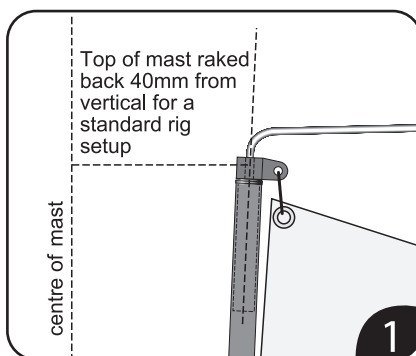
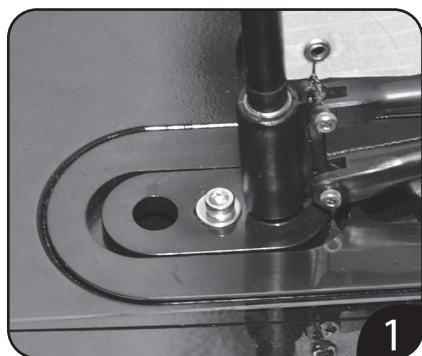

## MAIN BOOM & JIB BOOM RIGGING

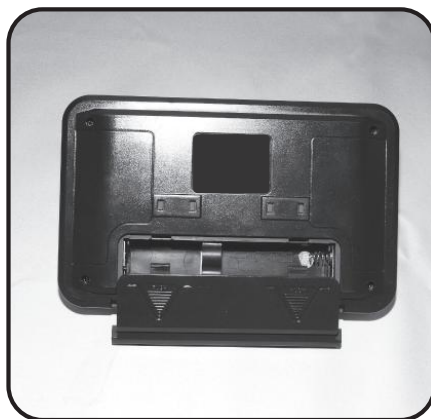

**Always use fresh AA alkaline battery in the transmitter.**

1. Ensure transmitter "POWER" switch is in the off position.
2. Slide off the battery door on the back of the transmitter.
3. Install 4 fresh "AA" alkaline batteries into the molded battery compartment of transmitter. Noting correct location (polarity + or -)
4. Re-install the battery door onto the back of transmitter.

NOTE: Suggest to keep the left stick (Throttle) on neutral position before switch on transmitter.

5. Switch on transmitter, you can hear "Bi" sound, transmitter green indicator light flash.

- Take the battery box for receiver out from the servo plastic tray inside the hull, install 4 fresh "AA" alkaline batteries into the battery box. Replace the battery box on the servo plastic tray and use velco strap to tie battery box securely on place.

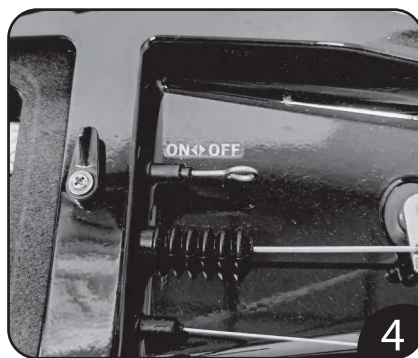
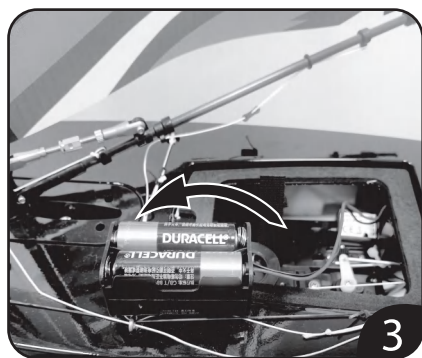

- Switch on receiver by pushing the pushrod forward to position "ON". Receiver red light is on, transmitter make "Bi Bi" sound, transmitter green indicator lights turn to solid on. Now both servos inside boat are under control correspondingly of radio control.

- Cut a length of Dyneema cord at around 550mm, attach it to one end eyelet of bowsie, the other end of cord thread through boom bend eye on MAIN BOOM as shown, then through bowsie's two holes in proper order (tips: bowsie closer to boom end eye for easy adjustment), cord through Rubber ring on main boom, then through another boom bend eye, through mainsheet metal ring, through Deck Eye 8, finally pull cord tight and attach cord to clip. Make sure main boom is pulled as on the centerline of hull. If not, adjust bowsie to pull main boom tight.

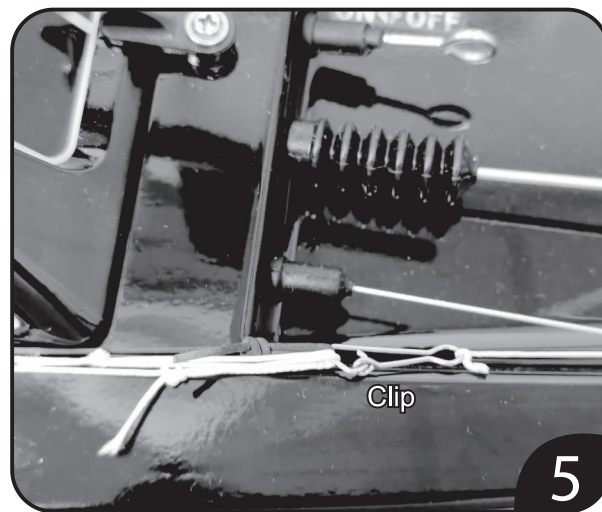
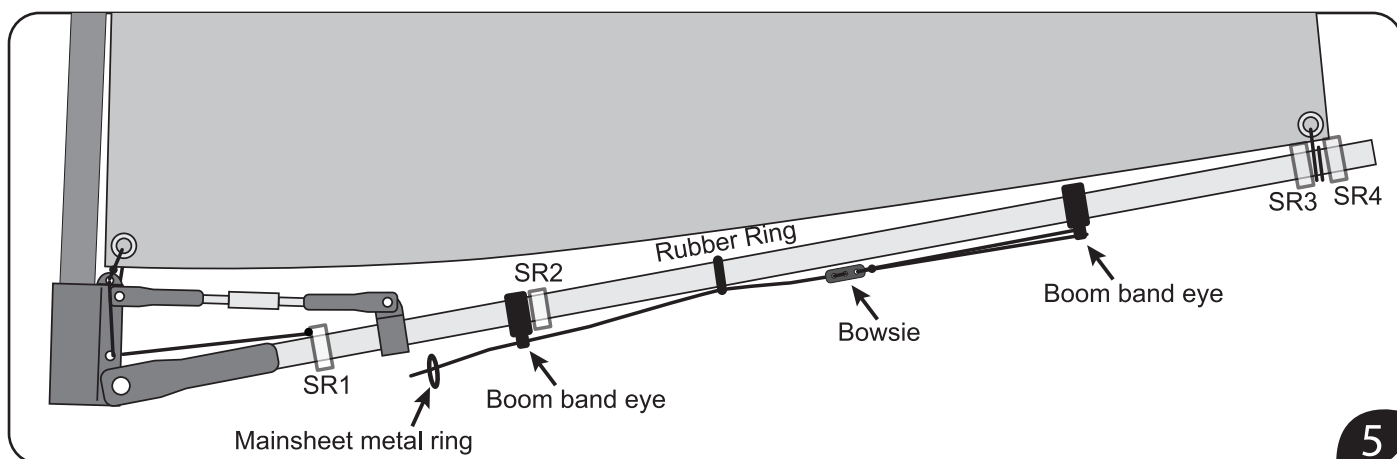

6. Cut a length of Dyneema cord at around 550mm, attach it to one end eyelet of bowsie, the other end of cord thread through boom bend eye on JIB BOOM as shown, then through bowsie's two holes in proper order (tips: bowsie closer to boom end eye for easy adjustment), cord through Rubber ring on jib boom, then through another boom bend eye, through deck eye 4, 5, 6 and 8, finally pull cord tight and attach cord to clip. Adjust bowsie, push jib boom away on either port or starboard, to make sure rear-end of Jib boom is moved away from mast at 30mm-35mm.

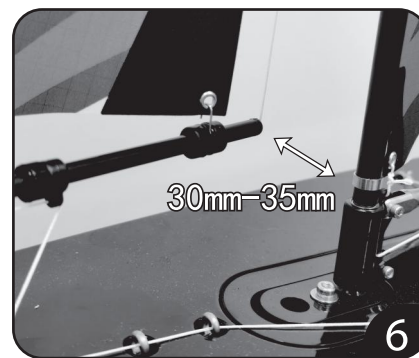
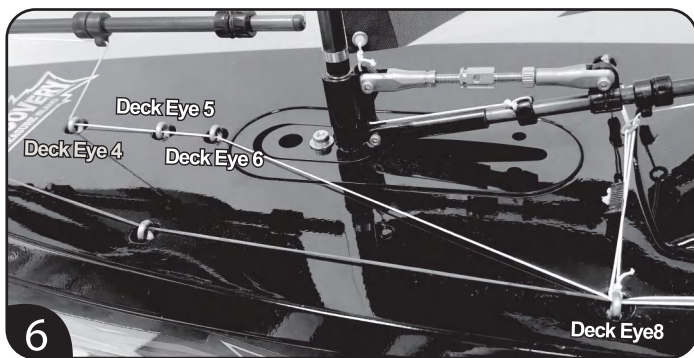
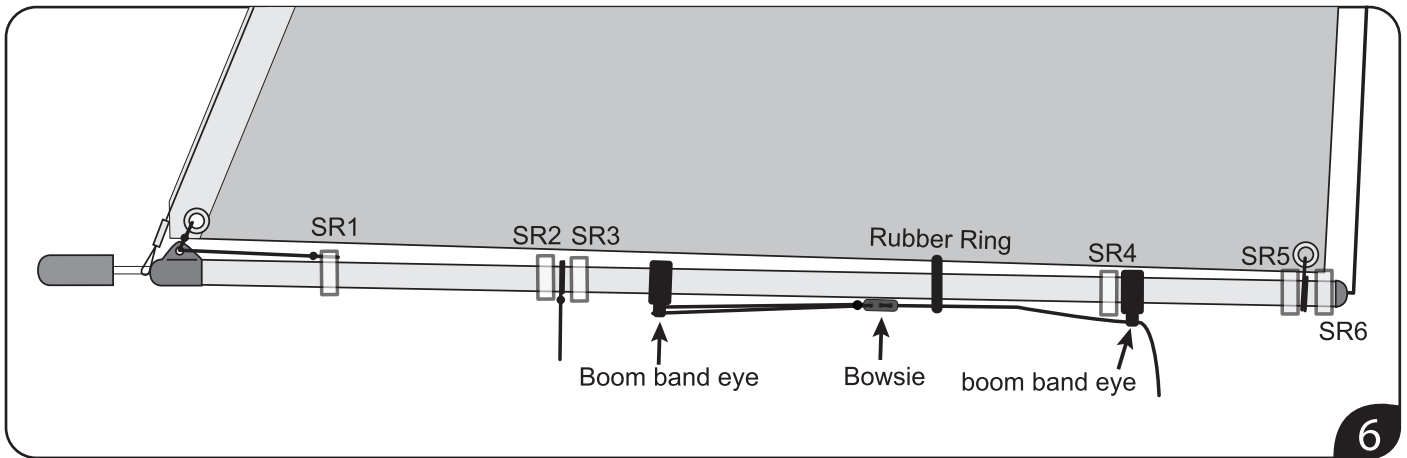

7. Switch on transmitter and push in Switch rod on deck to switch on receiver. Push up sail control stick (Left stick), sail winch servo will loose all cord out, move Mainsail and Jibsail away till the maximum angle, to make sure Mainsail could travel about 80°-90°, Jibsail could travel about 90°-100°, if not, adjust boom bend eye and SR2 position on MAIN BOOM to adjust its traveling angle. Adjust boom bend eye and SR4 position on JIB BOOM to adjust its traveling angle.

8. Move rudder control stick (right stick) left and right, rudder traveling angle to left and right are both around 35°. If not, adjust rudder servo neutral by pressing the rudder neutral position trim button on transmitter left or right. If still can't get it right, adjust pushrod by loosening screw on rudder arm.

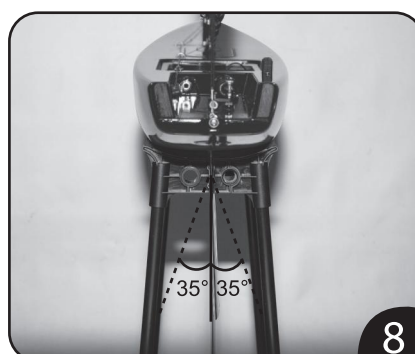
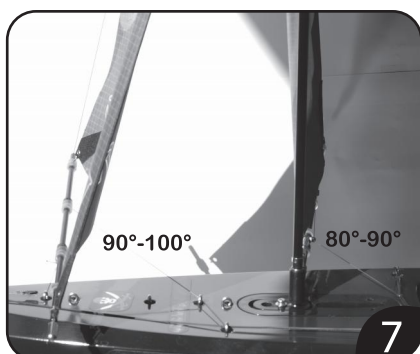

9. Rotate counterweight on front of jib boom by clockwise direction, adjust counterweight position, to make sure jib boom swing CG is located on SR2 and SR3 of Jib boom.
10. Turn off transmitter and power switch on deck, check all the cord tie and rigging, then insert the screw on hatch front end to the hole in the deck. then use the lock knob on deck to secure the hatch in place.

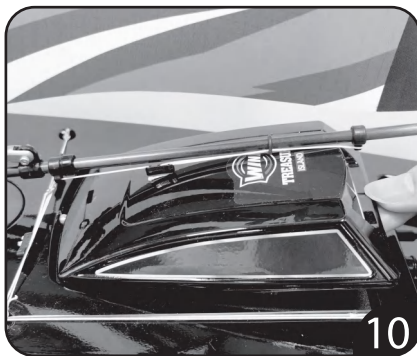

## TRANSMITTER & RECEIVER BINDING

J2C02 transmitter and J2C96R receiver are automatically binding once they are power on. No need to press any bind button. Just make sure no other transmitter or receiver should be powered on near by.

# PREPARATIONS FOR SAILING

Before sailing your Discovery for the first time, take note of the following:

1. **Always turn the transmitter on before the receiver, likewise, turn the receiver off before the transmitter.**
2. Check that each sail, rigging rings and fitting is properly installed and adjusted

Following the procedures to check the radio and sailboat's function:

1. For sail control stick, when stick is in the position of A, correspondingly, the main boom and jib boom are in the position of A as shown. When stick is in the position of B, correspondingly, the main boom and jib boom are in the position of B as shown. You may also adjust the sail servo neutral by pressing the sail neutral position trim button up or down.
2. For rudder control stick, rudder turn left when rudder control stick is pushed to the left. Rudder turn right when rudder control stick is pushed to the right. You may also adjust the rudder servo neutral by pressing the rudder neutral position trim button left or right

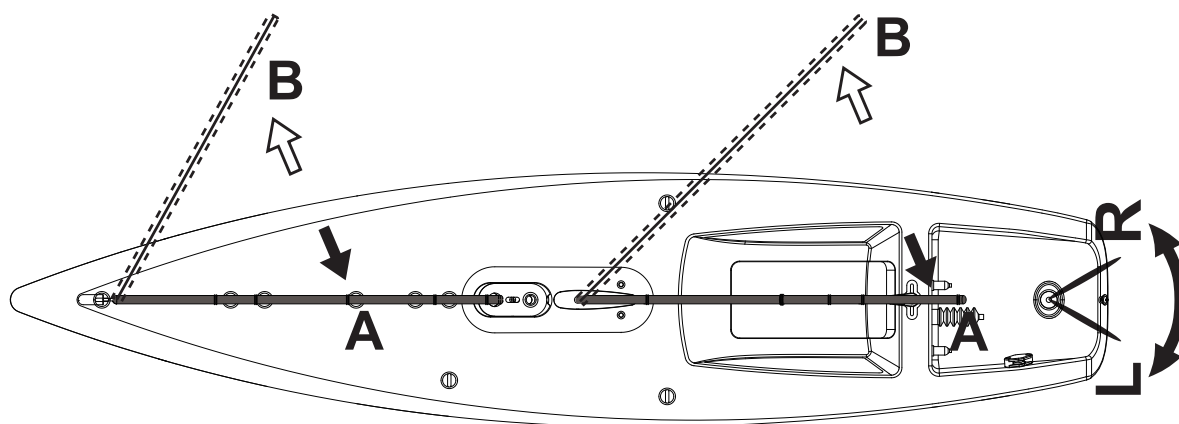
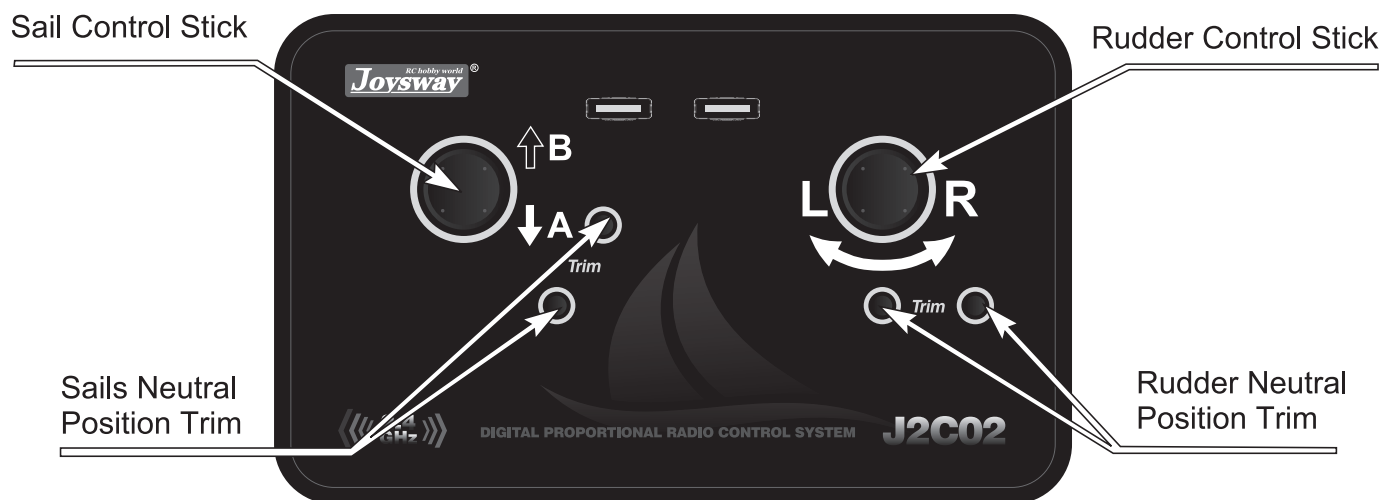

# SAILING THE DISCOVERY SAILBOAT

Unlike propeller driven boats that you basically point and accelerate, sailboats present an interesting challenge. Sailing requires constant reaction to water movements, any wind gusts, and any wind direction changes. These reactions then require adjustment of the rudder and sails in order to find the best possible course. There is no substitute for actual "on-the-water" experience and after your first couple of outings you may want to read through this manual again in order to help you to gain a better understanding of the "art" of sailing. While learning to sail, it is a good idea to pick up on as much sailing terminology as possible. This will make it easier to grasp some aspects.

## HOW TO SAIL DISCOVERY SAILBOAT

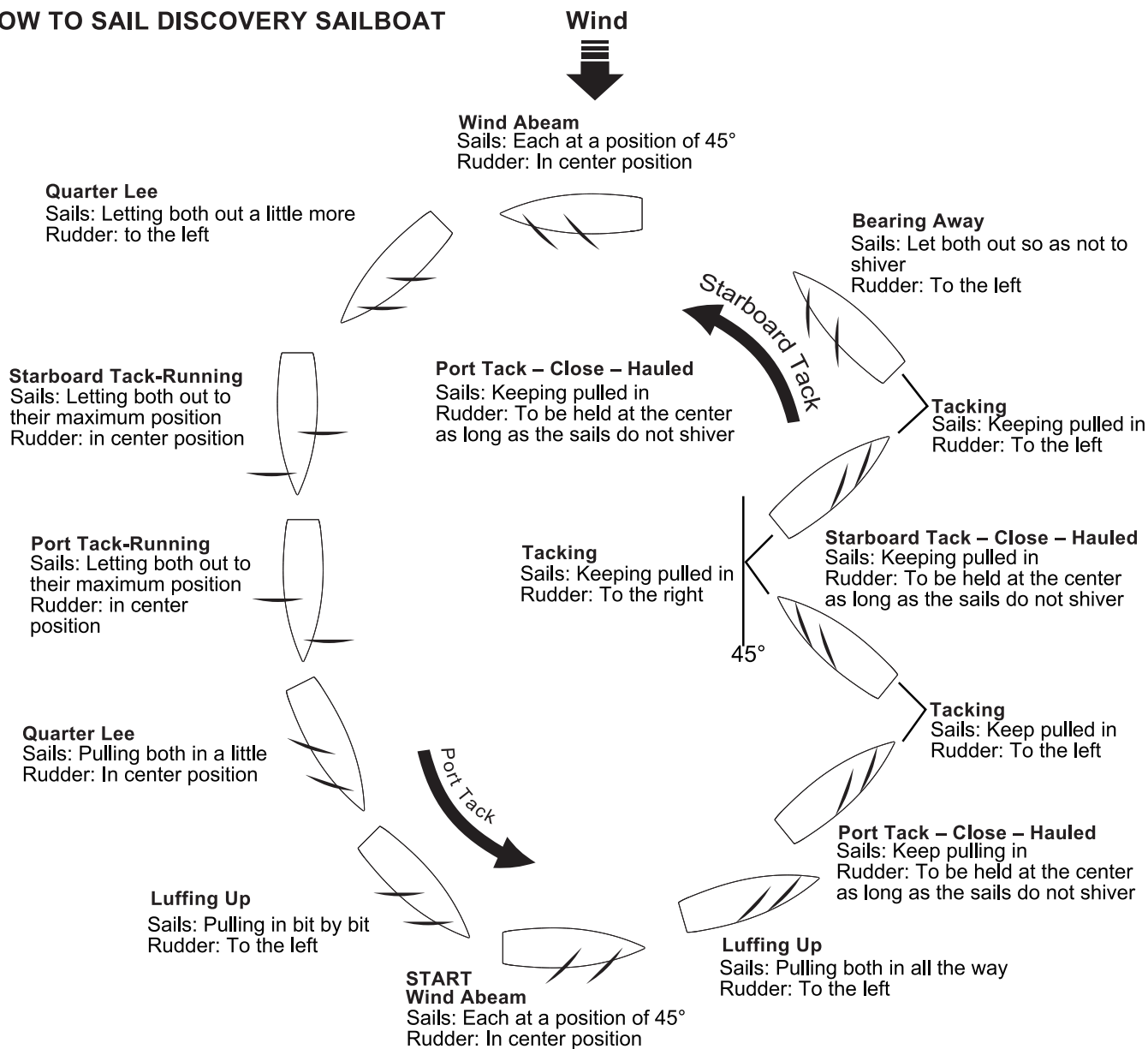

### IMPORTANT NOTICE:

1. Sail your Discovery only in still bodies of water. Never sail your boat in running water such as streams or rivers, as it is easy to lose control of your boat.
2. Never attempt to swim after a stalled or stuck boat! Wait patiently for the wind currents to return the boat to shore.
3. After running, remove the deck and allow the interior of the boat to dry out completely. If you neglect to do this, it may result in corrosion of the electronic components.

## SPARE PART LIST

To order Discovery spare parts, use the part numbers in the spare parts list that follows.

<b>PART NO.</b>	<b>DESCRIPTION</b>
881001	Discovery standard keel with screws
881002	Discovery front bumper (pk2)
881003	Discovery main sail & jib sail set
881004	Discovery Hull with painting (no decals)
881005	Discovery hatch(no decals)+Lock latch
881006	Discovery EVA gasket for hatch (PK2)
880204	J2C02 2.4GHz 2CH transmitter(2023 New TX)
880205	J2C96R 2.4GHz 4CH receiver(2023 New RX)
880313	servo plastic tray
880503	rudder
880504	550g standard ballast
880505	fin box and mast fitting
880510	Sheeting pulley block
880511	1m Sheeting elastic
880519	winch line rubber cap (pk2)
880529	masthead fitting
880535	Aluminum alloy rudder arm set
880536	Rubber bung (PK4)
880537	Jib boom counterbalance weight (PK4)
880542	Plastic molded boat stand
880544	pushrod with rubber bellow
880545	winch servo set
880549	Standard mast set w/ 4pcs protection metal ring
880552	Battery box for receiver
880554	Mast fitting tube
880558	Switch rod w/ rubber bellow & switch connector set
880565	mainsail luff rings (pk10)
880566	Metal kicker assembly
880567	Main boom Metal kicker assembly & fittings
880568	Jib boom & fitting
881210	Bowsie(PK10)
881228	Cord attachment clip (PK10)
881504	digital metal gear Rudder Servo
881507	5m White Dyneema
881526	Metal Rings (Pk 10)
881538	Silicone tube (Pk20)



[www.Joysway-Hobby.com](http://www.Joysway-Hobby.com)



#### FCC REQUIREMENT



This device complies with Part 15 of the FCC Rules. Operation is subject to the following two conditions: (1) This device may not cause harmful interference, and (2) This device must accept any interference received, including interference that may cause undesired operation.

CAUTION: Changes or modifications to this product not expressly approved by the party responsible for compliance may void the user's authority to operate the equipment.